

**CONTEMPORARY
CERAMIC
SURFACES**
&
**SIGNATURE
SURFACES**

REVERSE VEIN CUT

Travertine Stone in Ceramics

CONCEPT TILES



ARCHITECTURE

TEXTURES

SURFACES

Reverse Vein Cut

Travertine Stone in Ceramics
Piedra Travertino en Cerámica

The **Reverse** collection is inspired by travertine, a sedimentary rock formed from sediments settled in thermal waters and waterfalls. Livingceramics presents it with two types of graphics: vein cut, in which you can see the layers of sediment, and cross cut, which shows the cross section of the veins of the sediment layers, cut along the grain.

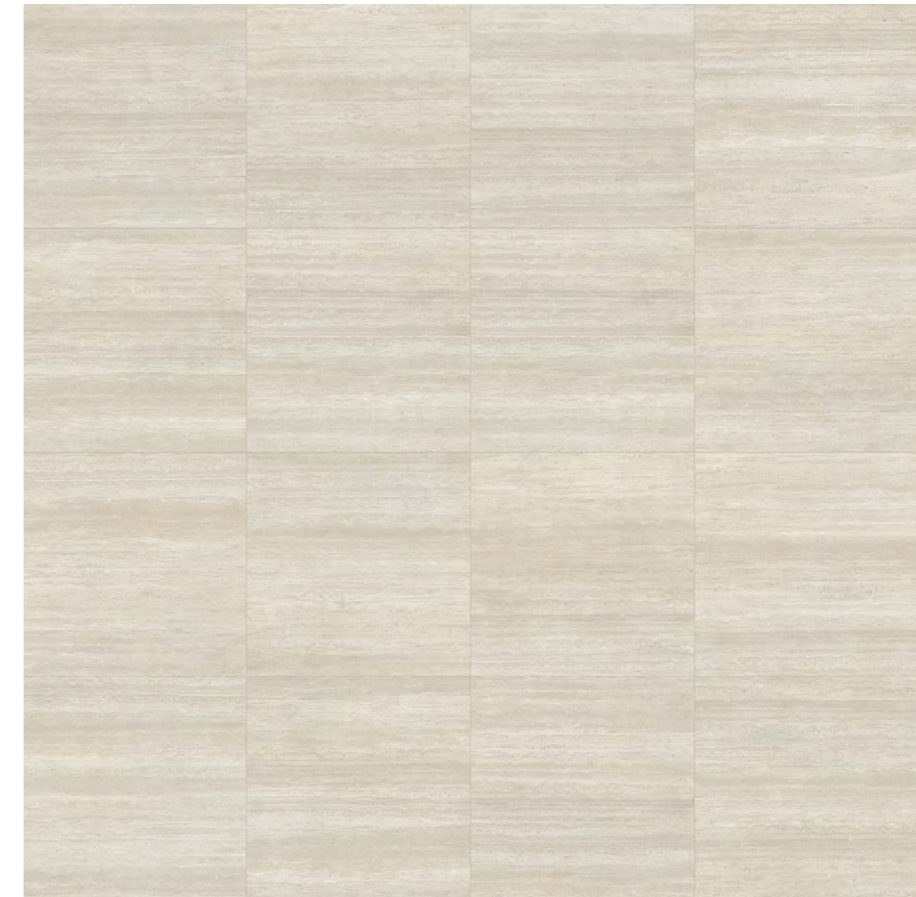

Reverse Vein Cut Soft Textured
90x90 cm. (36"x36") Composition



Reverse Vein Cut Chromatic Range



Reverse Vein Cut Light Soft
Textured 120x270 cm. (48"x106")

Bathroom Furniture Series
A.71 [240 cm.] Verso Vein Cut Light
Cross Dry Oak Line. 240



Reverse Vein Cut Light Soft
Textured 120x270 cm. (48"x106")



Reverse Vein Cut Classic Soft
Textured 90x270 cm. (36"x106")

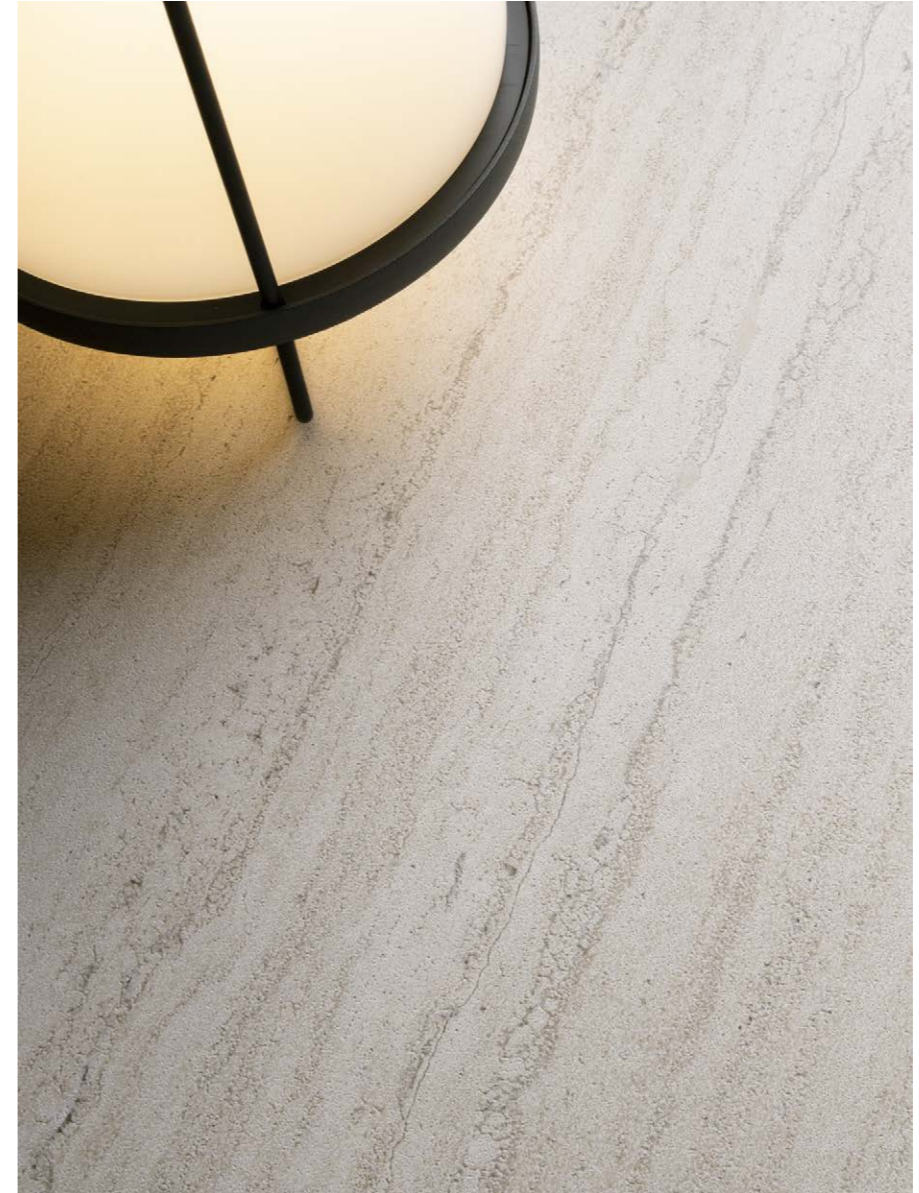

Reverse Vein Cut Classic Soft
Textured 120x270 cm. (48"x106")

Reverse Vein Cut

Travertine Stone in Ceramics
Piedra Travertino en Ceramica



Honed Finish Soft Textured Finish B.H. Finish B.H. Anti-Slip Finish

Color Body Porcelain & Ductile / Porcelánico Masa Coloreada y Ductile
Rectified / Destonified V.2 / Rectificado / Destonificado V.2
N° Designs By Format / N° De Diseños Por Formato :
 120x270: 7 / D-90x270: 7 / D-60x120: 24 / 120x120: 14 / 60x120: 24 / 90x90: 16 / 45x90: 32 / 60x60: 48 / 30x60: 96

3D-Fit®
Technology

Reverse Vein Cut
Classic Soft Textured
Finish Escala 1/4

Available Colours / Colores Disponibles

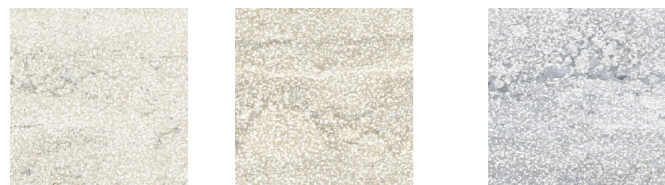

*Reverse Vein Cut Light *Reverse Vein Cut Classic Reverse Vein Cut Grey

*20mm. Thickness Available
Colour
*Color Disponible en 20mm.

Available Sizes / Formatos Disponibles

Step Tile & Countertops Available. Consult Special Pieces Section.
Peldaños y Encimeras disponibles. Consulte la Sección de Piezas Especiales.

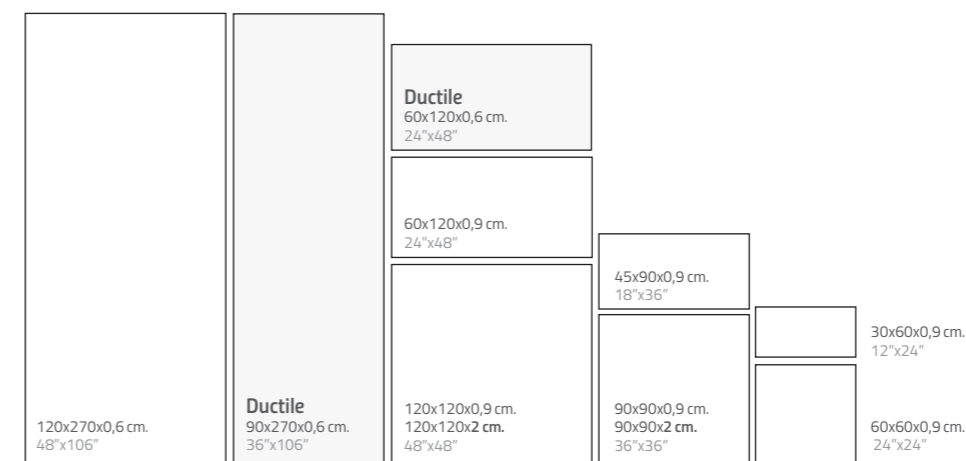

Complements / Complementos



Ductile Wall Tiles Available Sizes & Finishes / Formatos y Acabados Disponibles en Revestimientos Ductile

Nominal Size Formato Nominal	Real Size Formato Real	Soft Textured	Price Code	Pz/Box	M2/Box	Kg/Box	Box/Pa	M2/Pa	Kg/Pa
Ductile 60x120 cm. 24"x48"	59,8x119,8x0,6 cm.	●	620	3	2,15	25,80	30	64,50	841
Ductile 90x270 cm. 36"x106"	89,8x269,8x0,6 cm.	●	970	1	2,42	29,04	24	58,08	801

Porcelain Tiles Available Sizes & Finishes / Formatos y Acabados Disponibles en Porcelánico

Nominal Size Formato Nominal	Real Size Formato Real	Honed	Soft Textured C2-R10-CB	B.Hammered C2-R10-CB	B. H. Anti-Slip C3-R11-CC	Price Code	Pz/Box	M2/Box	Kg/Box	Box/Pa	M2/Pa	Kg/Pa
30x60 cm. 12"x24"	29,8x59,8x0,9 cm.	●	●		●	30 / 30H	6	1,07	22,00	48	51,36	1094
60x60 cm. 24"x24"	59,8x59,8x0,9 cm.	●	●		●	60 / 60H	3	1,07	23,22	48	51,36	1094
45x90 cm. 18"x36"	44,8x89,8x0,9 cm.	●	●		●	45 / 45H	3	1,21	25,50	48	58,08	1237
90x90 cm. 36"x36"	89,8x89,8x0,9 cm.	●	●		●	90 / 90H	2	1,61	34,00	30	48,30	1057
*90x90x2 cm. 36"x36"	89,8x89,8x2 cm.				●	94	1	0,81	37,09	30	24,30	1182
60x120 cm. 24"x48"	59,8x119,8x0,9 cm.	●	●		●	62 / 62H	2	1,43	30,32	36	51,48	1099
120x120 cm. 48"x48"	119,8x119,8x0,9 cm.	●	●		●	120 / 120H	1	1,44	30,50	40	57,41	1265
*120x120x2 cm. 48"x48"	119,8x119,8x2 cm.				●	121	1	1,44	66,02	16	22,96	1140
120x270 cm. 48"x106"	119,8x269,8x0,6 cm.	●	●	●		276 / 276H	1	3,23	45,50	24	77,52	1250
Mosaic 25	29,8x29,8x0,9 cm.	●	●		●	25 / 25H	5	0,44	9,00	60	26,40	576
Mosaic 55	29,8x29,8x0,9 cm.	●	●		●	55 / 55H	5	0,44	9,00	60	26,40	576
Mureto Mosaic	29,8x29,8x0,9 cm.	●	●		●	300 / 300H	5	0,44	9,00	40	17,60	395

Ductile Reliefs

The richness of the Reverse surface is reinforced by the two new wall tiles with relief. Arpa and Arco are reliefs created from parallel and symmetrical lines. The surface is flat and the grooves are in the shape of a semicircle. Both are available in two graphics. Vein Cut, the graphics in favor of the vein that reveals the travertine strata. And Cross Cut, the graphic against the vein.



3D-Fit®
Technology

Rectified / Destonificado V.2 / Rectificado / Destonificado V.2
Nº Designs By Format / Nº De Diseños Por Formato : D-60x120: 14-24

Reverse Vein Cut
Classic Arpa Relief
Graphic Scale 1/3

Reverse Vein Cut
Classic Arco Relief
Graphic Scale 1/3

Ductile Reliefs

Ductile Wall Tiles · Revestimientos Ductile

Available Sizes / Formatos Disponibles

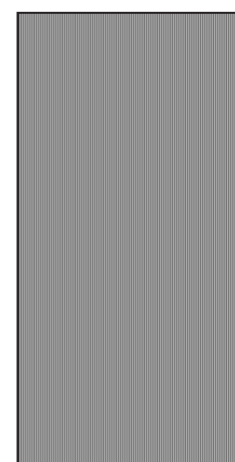

ARPA
Ductile
60x120x0,9 cm.
24"x48"

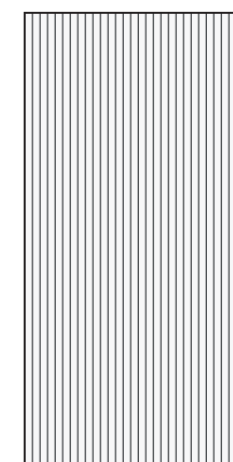

ARCO
Ductile
60x120x0,9 cm.
24"x48"

Available Colours / Colores Disponibles

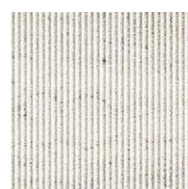

Reverse Vein Cut Light



Reverse Vein Cut Classic



Reverse Vein Cut Grey

Wall Tiles Available Sizes & Finishes / Formatos y Acabados Disponibles en Revestimientos Cerámicos

Nominal Size Formato Nominal	Real Size Formato Real	Arpa	Arco	Price Code	Pz/Box	M2/Box	Kg/Box	Box/Pa	M2/Pa	Kg/Pa
Ductile Relief 60x120 cm. 24"x48"	59,8x119,8x0,9 cm.	●	●	620	2	1,43	22,00	36	51,48	824

9&20MM THICKNESS

STANDARD STEP TILES

Standard Step Tiles Specifications Especificaciones De Peldaños Estándar

COLOR BODY PORCELAIN / PORCELÁNICO MASA COLOREADA
RECTIFIED / REINFORCEMENT SIDES / RECTIFICADO / REFUERZO DE CANTOS

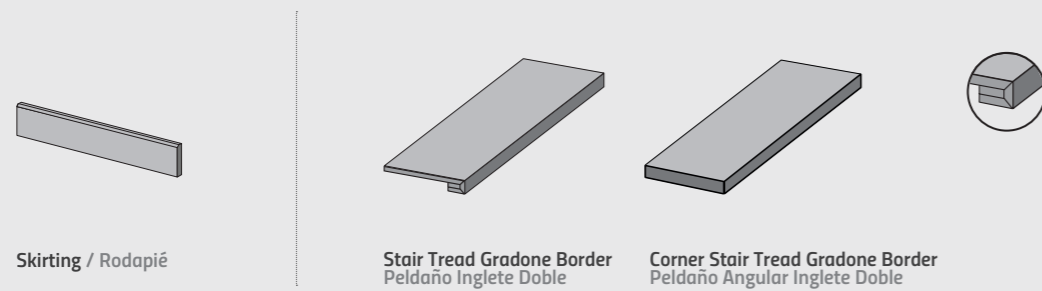

Skirting / Rodapié

Stair Tread Gradone Border
Peldaño Inglete Doble

Corner Stair Tread Gradone Border
Peldaño Angular Inglete Doble

Other Special Pieces Otras Piezas Especiales

Our solutions include customized steps from our mass colored porcelain lines. It is a product capable of adjusting to any type of stairs: catalan stair, floating stairs, turning floating stairs. The measurements and data are recorded in a simple form, collecting the necessary information for cutting the steps.

Nuestras soluciones incluyen peldaños a medida de nuestras colecciones de porcelánico de masa coloreada. Un producto a medida capaz de adecuarse a cualquier tipo de escalera: escalera catalana, escalera colgada, de ojo colgada... Los datos y medidas se anotan en un sencillo formulario que recoge toda la información necesaria para el corte de los peldaños.

Tailored Step Tiles Specifications. OTHER FINISHES Especificaciones De Peldaños A Medida. OTROS ACABADOS

COLOR BODY PORCELAIN / PORCELÁNICO MASA COLOREADA
RECTIFIED / REINFORCEMENT SIDES / RECTIFICADO / REFUERZO DE CANTOS

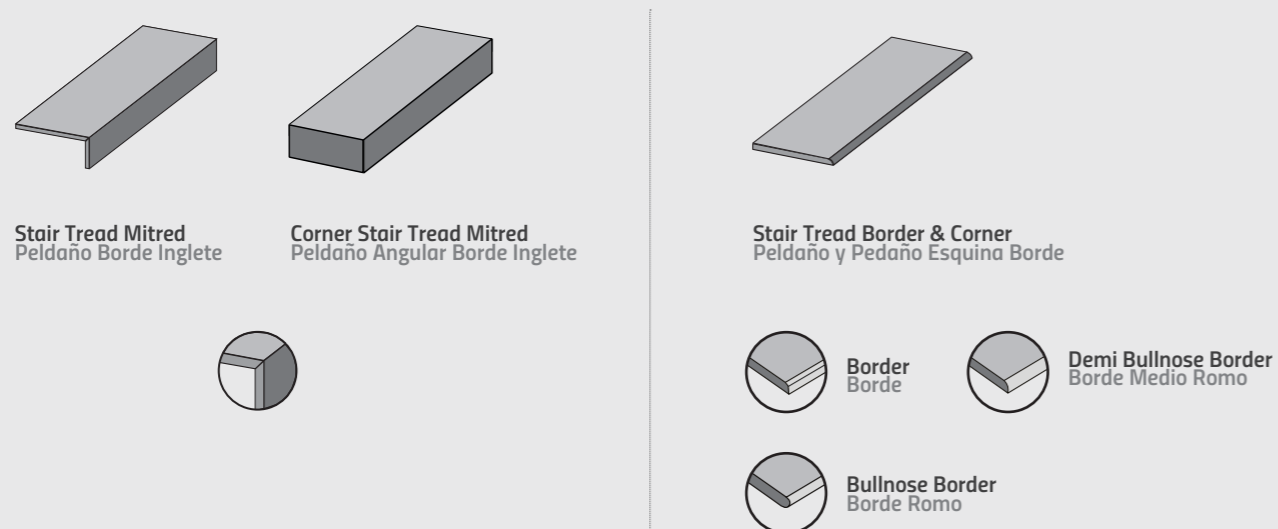

Stair Tread Mitred
Peldaño Borde Inglete

Corner Stair Tread Mitred
Peldaño Angular Borde Inglete

Stair Tread Border & Corner
Peldaño y Peldaño Esquina Borde

Border
Borde

Demi Bullnose Border
Borde Medio Romo

Bullnose Border
Borde Romo

POOL SPECIAL PIECES

20MM Pool Grid Example
Ejemplo Rejillas 20MM



Special Pieces / Pool Grids Piezas Especiales / Rejillas de Piscina

Extra-thick porcelain tiles offer numerous benefits, thanks to their versatility and high resistance. These are properties fully able to meet the tough technical demands and aesthetic requirements of outdoor spaces, public areas, and places subject to high loads or stresses. The tiles can be used in false floor systems, creating raised access flooring that provides easy access to plumbing and electricity networks. They are swift and easy to lay, and the perfect choice for outdoor areas.

El gres porcelánico espesorado ofrece múltiples ventajas gracias a su elevada resistencia y versatilidad. Características que responden a las más altas exigencias a nivel técnico y estético que requieren zonas de exterior, áreas públicas y zonas sometidas a altas cargas y tensiones. Permite su ejecución en sistemas registrables, ofreciendo suelos técnicos elevados fácilmente accesibles a instalaciones de fontanería y electricidad. Rápido y fácil en su ejecución, se trata de un material perfecto para el pavimentado de exteriores.

20MM Standard Pieces for Pools Piezas Estándar para Piscinas en 20MM

COLOR BODY PORCELAIN / PORCELÁNICO MASA COLOREADA
RECTIFIED / REINFORCEMENT SIDES / RECTIFICADO / REFUERZO DE CANTOS

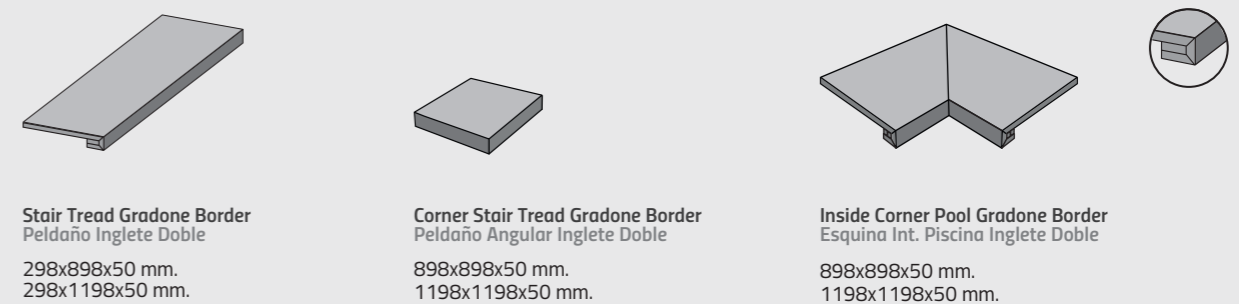

Stair Tread Gradone Border
Peldaño Inglete Doble
298x898x50 mm.
298x1198x50 mm.

Corner Stair Tread Gradone Border
Peldaño Angular Inglete Doble
898x898x50 mm.
1198x1198x50 mm.

Inside Corner Pool Gradone Border
Esquina Int. Piscina Inglete Doble
898x898x50 mm.
1198x1198x50 mm.

Tailored Step Tiles Specifications. OTHER POOL FINISHES Especificaciones De Peldaños A Medida. OTROS ACABADOS PARA PISCINAS

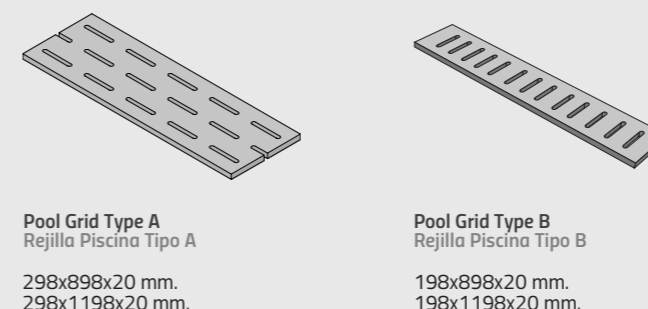

Pool Grid Type A
Rejilla Piscina Tipo A
298x898x20 mm.
298x1198x20 mm.

Pool Grid Type B
Rejilla Piscina Tipo B
198x898x20 mm.
198x1198x20 mm.

Recommendations / Recomendaciones

Livingceramics recommends consulting the norms that regulate the placement of ceramic tiles. It is essential, before any installation, to carefully read the **UNE 138002 and UNE 12004** standard, and to attend to the specified in order to achieve a correct placement of the ceramic tile. We indicate below, a summary of the most important points to take into account:

Livingceramics recomienda consultar la normativa que regula la colocación de baldosas cerámicas. Es indispensable, antes de cualquier instalación, leer con detenimiento la norma **UNE 138002 y UNE 12004**, y atender a lo especificado con el fin de conseguir una correcta colocación de la baldosa cerámica. Señalamos a continuación, un resumen de los puntos más importantes a tener en cuenta:

Installation Recommendations / Recomendaciones De Instalación

- 1 CONFORMITY OF TONE AND CALIBER OF THE MATERIAL.
VERIFICAR EL DESTONIFICADO DEL MATERIAL.
- 2 MAKE SURE THAT THE AREA TO CLAD IS CLEAN AND DRY.
ASEGURAR QUE LA ZONA A REVESTIR ESTÁ LIMPIA Y SECA.
- 3 CEMENT-BASED ADHESIVE SHOULD BE USED FOR EACH TYPE OF PRODUCT; PORCELAIN COLOR BODY OR WHITE BODY.
UTILIZAR EL ADHESIVO DE CLASE CEMENTO COLA SEGÚN TIPOLOGÍA DE PRODUCTO; PORCELÁNICO MASA COLOREADA O PASTA BLANCA.
- 4 THE AREA TO CLAD MUST BE UNIFORMLY LEVELED. THE USE OF LEVELING SYSTEMS IS MANDATORY FOR A PERFECT INSTALLATION.
EL USO DE SISTEMAS DE NIVELACIÓN ES OBLIGATORIO PARA UNA PERFECTA COLOCACIÓN. LA ZONA A REVESTIR DEBE ESTAR PERFECTAMENTE NIVELADA.
- 5 A 2 MM MINIMUM JOINT IS RECOMMENDED TO PLACE THE PIECES CORRECTLY.
SE RECOMIENDA UNA JUNTA MÍNIMA DE 2 MM PARA LA COLOCACIÓN ENTRE PIEZAS.
- 6 THE RECTANGULAR FORMATS CANNOT BE PLACED UNITED TO ANY MORE THAN 1/4 OF THE PIECE.
LOS FORMATOS RECTANGULARES NO SE PUEDEN COLOCAR TRABADOS A MÁS DE 1/4 DE LA PIEZA.

THE SLAB INSTALLATION REQUIRES THE USE OF TOOLS AND SPECIFIC TRAINING BY THE INSTALLER. IN ADDITION TO THE ABOVE, THESE ARE SOME OF THE RECOMMENDATIONS TO TAKE INTO ACCOUNT IN THE INSTALLATION OF LARGE TILE FORMATS:

LA INSTALACIÓN DE GRANDES FORMATOS REQUIERE DE HERRAMIENTAS Y UNA FORMACIÓN ESPECÍFICA POR PARTE DEL COLOCADOR. A DEMÁS DE LAS ANTERIORES, ESTAS SON ALGUNAS DE LAS RECOMENDACIONES A TENER EN CUENTA EN LA INSTALACIÓN DE GRANDES FORMATOS CERÁMICOS:



CUTTING DETAIL WITH GUIDE ON SLAB
DETALLE DE CORTE CON GUÍA SOBRE PLANCHA



THE TILES' DUCTILE PROPERTIES MAKE THEM EASY TO CUT
LAS PROPIEDADES ESPECIALES DE DUCTILE LO HACEN MÁS FÁCIL DE CORTAR

- 7 THE DOUBLE BONDING TECHNIQUE MUST ALWAYS BE USED.
SE HA DE EMPLEAR SIEMPRE LA TÉCNICA DEL DOBLE ENCOLADO.

**THE DOUBLE BONDING TECHNIQUE MUST ALWAYS BE USED.
SE HA DE EMPLEAR SIEMPRE LA TÉCNICA DEL DOBLE ENCOLADO.**

- 8 THIS MATERIAL REQUIRES THE USE OF C2 CLASS ADHESIVES (BICOMPONENT TYPE S2).
ES RECOMENDABLE EL USO DE ADHESIVOS CLASE C2 ALTAMENTE FLEXIBLES (BICOMPONENTES TIPO S2).

- 9 THE APPEARANCE OF AIR POCKETS BETWEEN TILE AND SUBSTRATE SHOULD BE AVOIDED BY THE SYSTEMATIC KNOCKING OF THE TILE WITH A RUBBER TROWEL. THIS WILL AVOID TENSIONS AND BREAKS AFTER THE MATERIAL HAS BEEN SET.
SE DEBERÁ EVITAR LA APARICIÓN DE BOLSAS DE AIRE ENTRE BALDOSA Y SUSTRATO MEDIANTE EL GOLPEADO SISTEMÁTICO DE LA CERÁMICA CON UNA LLANA DE GOMA. ESTO EVITARÁ TENSIONES Y ROTURAS TRAS EL FRAGUADO DEL MATERIAL.

- 10 THE USE OF SPECIFIC TOOLS FOR INSTALLING CERAMIC TILES IS MANDATORY. CONSULT YOUR TRUSTED SUPPLIER TO RECEIVE INSTRUCTIONS ON THE CORRECT HANDLING OF THESE TOOLS AND THEIR NEEDS.
ES INDISPENSABLE UTILIZAR HERRAMIENTAS ESPECÍFICAS PARA EL ALICATADO DEL GRAN FORMATO CERÁMICO. CONSULTE CON SU PROVEEDOR DE CONFIANZA PARA RECIBIR INTRUCCIONES DEL CORRECTO MANEJO DE ESTAS HERRAMIENTAS Y SUS NECESIDADES.

Play Video / Reproducir Video



BIG SLAB INSTALLATION
INSTALACIÓN DEL GRAN FORMATO

Cleaning & Maintenance / Limpieza & Mantenimiento

Once placed and grout cleaning equipment is mandatory. Improper cleaning may leave traces of products used in the placement or the protection of the tiles, as cements, resins epoxilicas, grout, waxes or fats. For optimal cleaning after placement for cases of intense and stubborn dirt accumulated over time, and for maintenance, required to use the right products. The following table shows some of the recommendations.

Una vez colocado y rejuntado el material es obligatoria la limpieza. Una limpieza incorrecta puede dejar restos de productos empleados en la colocación o de la protección de las baldosas, como cementos, resinas epoxilicas, material de rejuntado, ceras o grasas. Para una optima limpieza tras la colocación, para casos de suciedad intensa e incrustada acumulada en el tiempo, y para su mantenimiento, se precisa emplear los productos adecuados. En la tabla siguiente mostramos algunas de las recomendaciones.

FILACLEANER	MAINTENANCE IN GENERAL. MANTENIMIENTO EN GENERAL.
FILACR10	WASTE EPOXY, VITRIFIED OR RESIN BOARD. RESIDUOS DE JUNTA EPOXI, JUNTA VITRIFICADA O JUNTA RESINOSA.
DETERDEK	WASTE CONCRETE PLACEMENT, LIMESCALE, METALS STRIPES, OXIDE DEPOSITS. RESIDUOS DE CEMENTO DE COLOCACIÓN, RESIDUOS CALCÁREOS, RAYAS METALES, DEPOSITOS DE ÓXIDO.
FILASOLV	CANDLE WAX, TREE RESINS, TAPE RESIDUE, TAR RESIDUE. CERA DE VELAS, RESINA DE ÁRBOL, RESIDUOS DE CINTA ADHESIVA, RESIDUOS ALQUITRÁN.
FILANOPAINT STAR	PAINTED GRAFFITI, SPRAY ACRYLIC, ALKYD AND SYNTHETIC NITROS. PINTADAS DE GRAFITIS, SPRAY ACRÍLICOS, ALQUÍDICOS Y NITROS SINTÉTICOS.
FILAPS87	DRINKS, FOOD, FATS, OILS, RUBBER, DYES, MARKER, ACRYLIC PAINT DROPS. BEBIDAS, COMIDAS, GRASAS, ACEITES, GOMA, TINTES, ROTULADOR, GOTAS DE PINTURA PLÁSTICA.